

Phoenix

DESIGNED FOR YOU

TECHNICAL DATA SHEET

PRODUCT RANGE	Designer radiator
PRODUCT TYPE	Sophia
PRODUCT CODE	RA056 / EA056
FINISH	Chrome

TECHNICAL LINE DRAWING AND SIZES

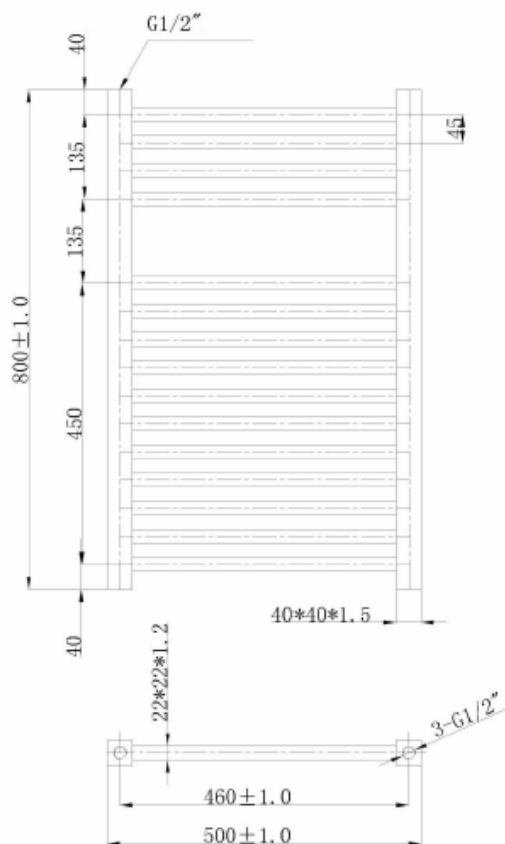

ADDITIONAL INFORMATION

Size (H * W)	Overall Depth	Overall Depth when mounted	Tapping/ Pipe Inlet Centres	Weight	BTU Output Delta r50	Watts Output Delta r50	BTU Output Delta r60	Watts Output Delta r60	Litre Capacity
800 * 500	40	82	460	13					4.61
800 * 500	40	82	460	7.89	1734	508	2,192	642	4.61

GUARANTEE AND AFTERCARE

During installation extra care must be taken to avoid damaging the fittings. We provide a guarantee against faulty manufacture or materials (excluding serviceable parts), providing they have been installed, cared for and used in accordance with our instructions and good plumbing practice.

Contact Us: Email: sales@phoenixwhirlpools.co.uk
Tel: +44 (0)113 201 2260
Fax: +44 (0)113 201 2268

Phoenix

DESIGNED FOR YOU

TECHNICAL DATA SHEET

PRODUCT RANGE	Designer radiator
PRODUCT TYPE	Sophia
PRODUCT CODE	RA057 / EA057
FINISH	Chrome

TECHNICAL LINE DRAWING AND SIZES

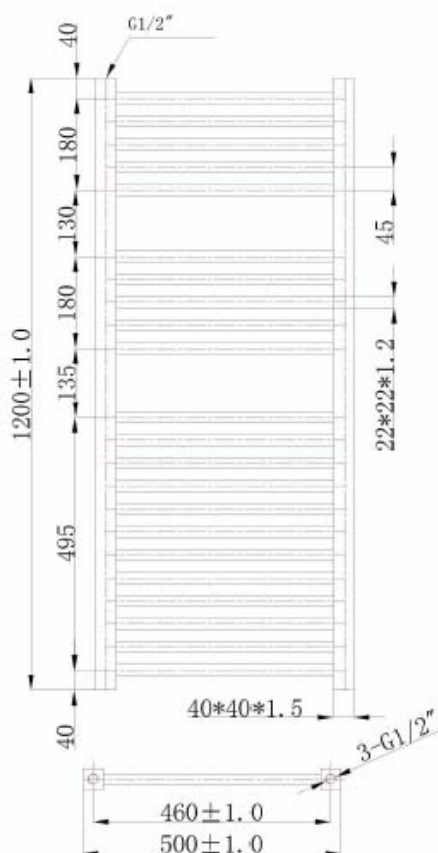

ADDITIONAL INFORMATION

Size (H * W)	Overall Depth	Overall Depth when mounted	Tapping/ Pipe Inlet Centres	Weight	BTU Output Delta 50	Watts Output Delta r50	BTU Output Delta r60	Watts Output Delta r60	Litre Capacity
1200 * 500	40	82	460	19.02					6.84
1200 * 500	40	82	460	11.68	2503	734	3,164	927	6.84

GUARANTEE AND AFTERCARE

During installation extra care must be taken to avoid damaging the fittings. We provide a guarantee against faulty manufacture or materials (excluding serviceable parts), providing they have been installed, cared for and used in accordance with our instructions and good plumbing practice.

Contact Us: Email: sales@phoenixwhirlpools.co.uk
Tel: +44 (0)113 201 2260
Fax: +44 (0)113 201 2268

Phoenix

DESIGNED FOR YOU

TECHNICAL DATA SHEET

PRODUCT RANGE	Designer radiator
PRODUCT TYPE	Sophia
PRODUCT CODE	RA058 / EA058
FINISH	Chrome

TECHNICAL LINE DRAWING AND SIZES

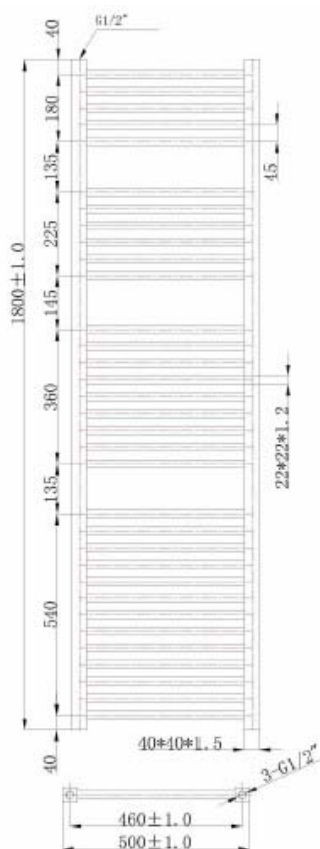

ADDITIONAL INFORMATION

Size (H * W)	Overall Depth	Overall Depth when mounted	Tapping/Pipe Inlet Centres	Weight	BTU Output Delta 50	Watts Output Delta r50	BTU Output Delta r60	Watts Output Delta r60	Litre Capacity
1800 * 500	40	82	460	28.26					10.25
1800 * 500	40	82	460	17.51	3618	1060	4,573	1340	10.25

GUARANTEE AND AFTERCARE













During installation extra care must be taken to avoid damaging the fittings. We provide a guarantee against faulty manufacture or materials (excluding serviceable parts), providing they have been installed, cared for and used in accordance with our instructions and good plumbing practice.

Contact Us: Email: sales@phoenixwhirlpools.co.uk
Tel: +44 (0)113 201 2260
Fax: +44 (0)113 201 2268







INSTALLATION GUIDE

Assembly Instructions for Ladder Rail

Contents List

Ref		Description	Quantity
A		Ladder Rail	1
B		Blanking Plug	1
C		Air Vent Plug	1
D		Wall Support	4
E		Masonry Wall Plug	4
F		Long Screw	4
G		Small Screw	4
H		Spacer	4
I		End Cap	4
J		Cross Bolt	4
K		Bracket Bush	8
L		Rubber Ring	4

Tools Required(not supplied)

	Description
	PTFE Tape
	Large Flat Screwdriver
	8mm Masonry Bit or 3mm Wood Bit
	Socket Set
	Spanner
	Clean Cloth

Prior to Installation

- Check that all of the parts are enclosed as per the contents list.
- If there are any missing or damaged parts please contact your supplier immediately.
- The four plastic caps on each corner of the ladder rail should be removed and disposed of.

Assembly

- 1 Select your desired installation position and ensure that the wall is sufficiently strong enough to hold the weight of the ladder rail. Brick or breezeblock walls are ideal. If positioning on plaster-board wall it **MUST** be fixed to timber batons.

- 2 Screw the blanking plug **B** and air vent plug **C** into the top two threads in the upright channels of the ladder rail **A**. They can fitted on either side. Using a cloth to prevent scratching, tighten with a spanner. Apply PTFE tape.

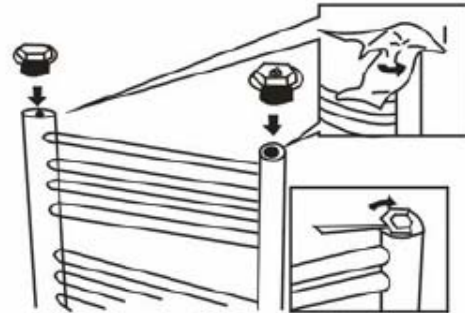

- 3 Thread the tails from the valves (not supplied) into the bottom two threads. Apply PTFE tape.

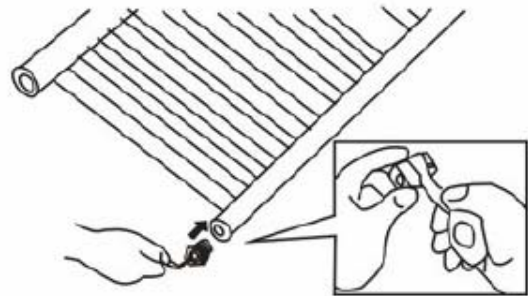

- 4 The wall supports should be fitted at approximately 10cms from the inside edge of the ladder rail - 2 near the top of the ladder rail and 2 near the bottom. The mounting height can be varied between any of the ladder rail bars to allow for finding the best fixing point on the wall. Mark the fixing points with a pencil.

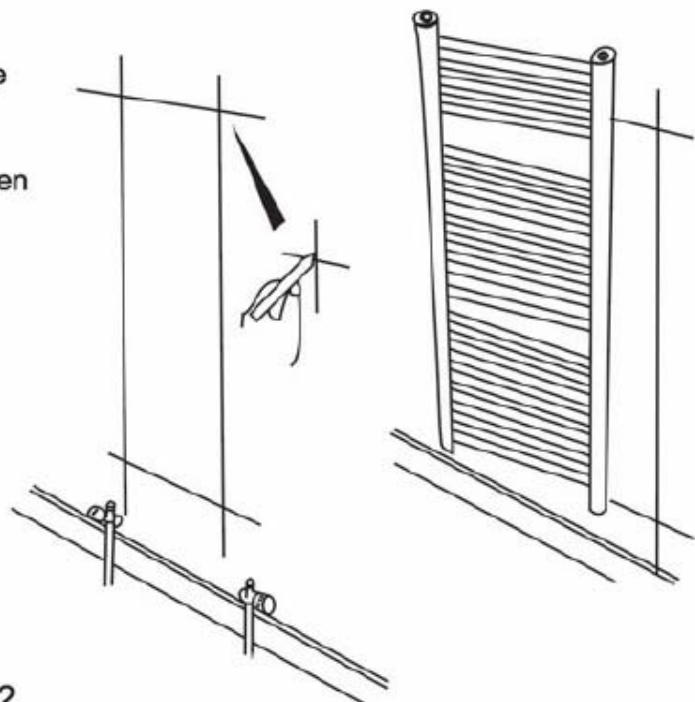

- 5 Mounting to Brick or Breezeblock
 At the required fixing positions drill hole using 8mm masonry bit and insert the wall plug E into the hole ensuring it's flush with the wall. Place long screw F through the centre of the wall support D and tighten into the wall plug.

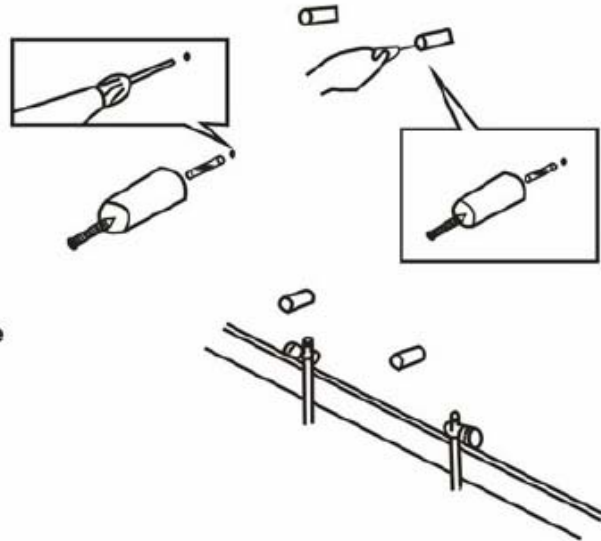

Mounting to Wood

Place long screw F through the centre of the wall support D and screw into the wooden baton at the required fixing positions.

- 6 Place the spacer H inside the wall support and insert the small screw G into the hole in the wall support. Don't over-tighten to allow for adjustment later.

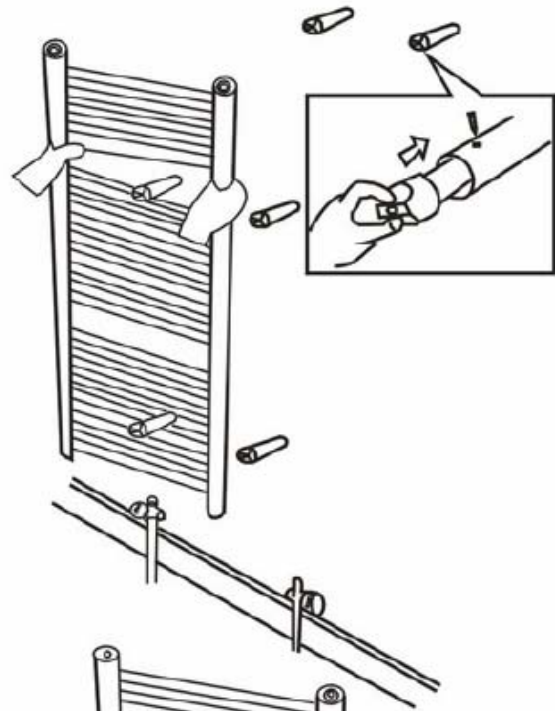

- 7 Offer the ladder rail A up to the fixing brackets and place bolt J through the bracket bush K.



Place the bolt between the selected ladder rail bars and thread into the wall support ensuring the square face of the bracket bush is aligned with the ladder rail.

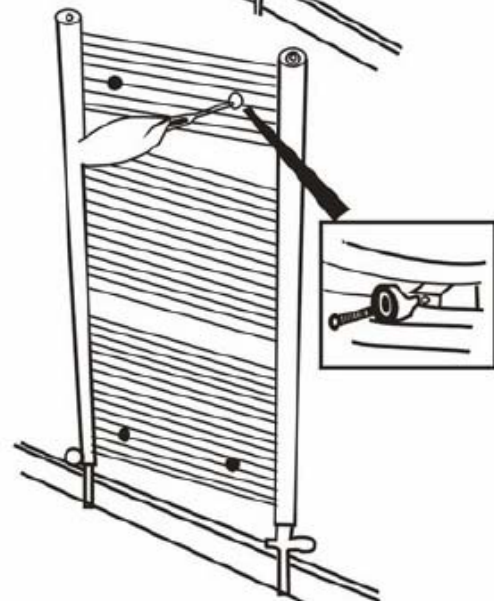

- 8 Push the rail flat against the wall, adjust to required depth and tighten the small screws to secure. Push the end caps I over each of the bracket heads until they click into position.

- 9 Connect the valve tail to the ladder rail and tighten securely. Apply PTFE tape.

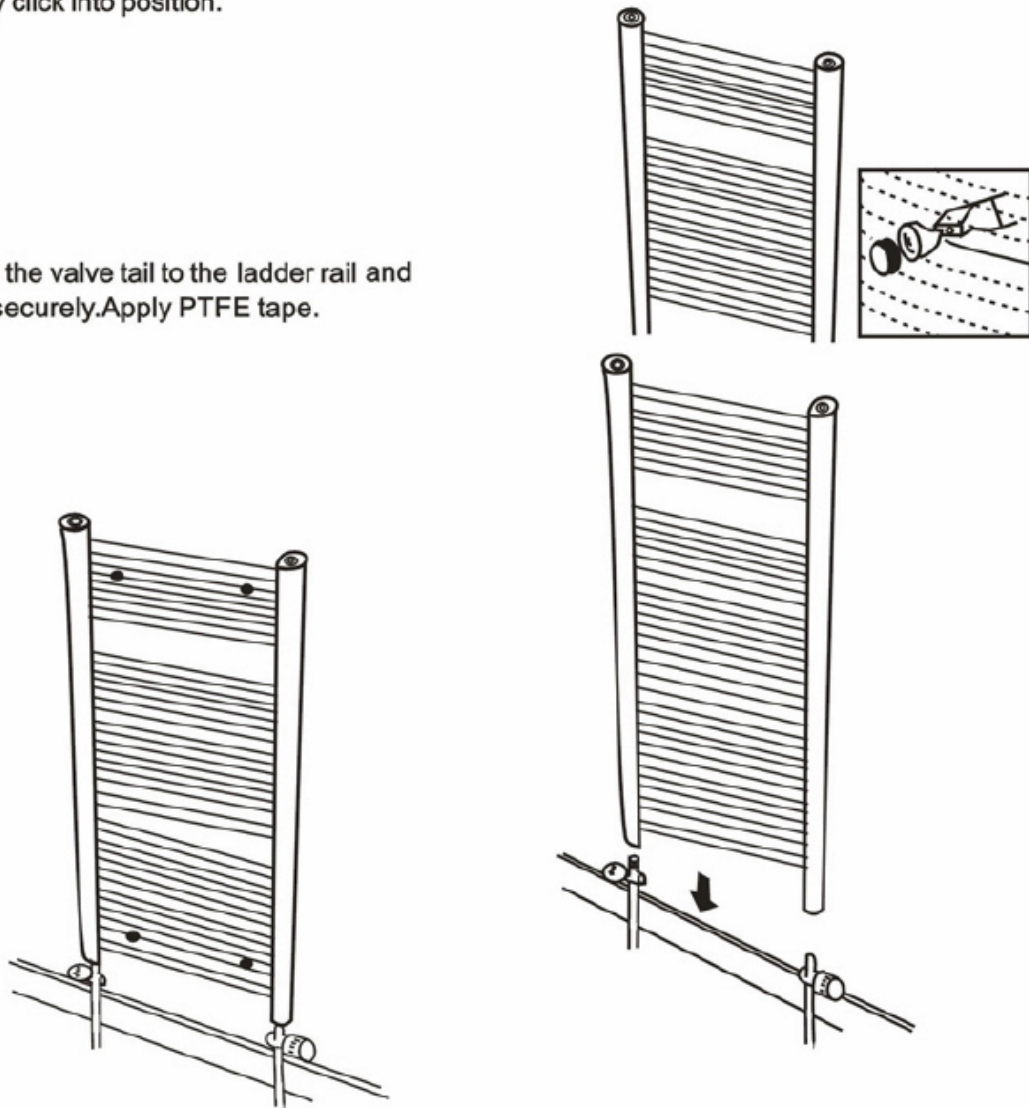

Important

- Wipe the surface clean with a soft, damp cloth. Never use abrasive cleaners on this product as they will damage the surface.