

# Phoenix

DESIGNED FOR YOU

## TECHNICAL DATA SHEET

<b>PRODUCT RANGE</b>	Designer radiator
<b>PRODUCT TYPE</b>	Crysta
<b>PRODUCT CODE</b>	RA906 / EA906
<b>FINISH</b>	Chrome

## TECHNICAL LINE DRAWING AND SIZES

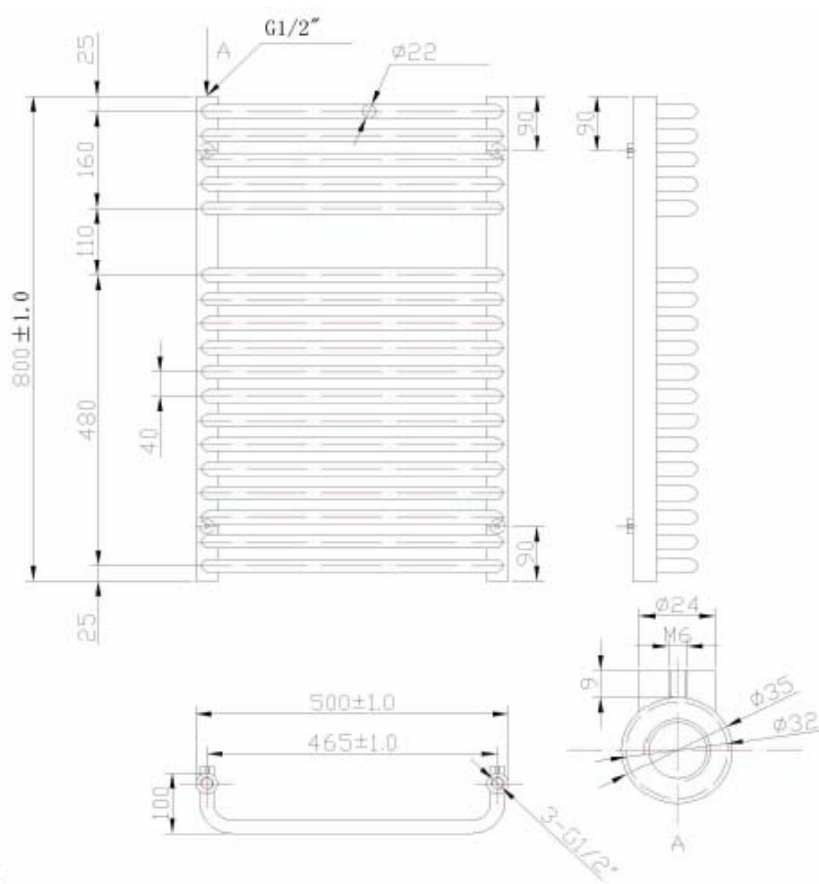

## ADDITIONAL INFORMATION

Size (H * W)	Overall Depth	Overall Depth when mounted	Tapping/ Pipe Inlet Centres	Weight	BTU Output Delta r50	Watts Output Delta r50	BTU Output Delta r60	Watts Output Delta r60	Litre Capacity
800 * 500	110	175	465	8.94					3.91
800 * 500	110	175	465	8.94	1014	297	1,282	376	3.91

## GUARANTEE AND AFTERCARE

During installation extra care must be taken to avoid damaging the fittings. We provide a guarantee against faulty manufacture or materials (excluding serviceable parts), providing they have been installed, cared for and used in accordance with our instructions and good plumbing practice.

Contact Us: Email: [sales@phoenixwhirlpools.co.uk](mailto:sales@phoenixwhirlpools.co.uk)  
Tel: +44 (0)113 201 2260  
Fax: +44 (0)113 201 2268

# Phoenix

DESIGNED FOR YOU

## TECHNICAL DATA SHEET

<b>PRODUCT RANGE</b>	Designer radiator
<b>PRODUCT TYPE</b>	Crysta
<b>PRODUCT CODE</b>	RA907 / EA907
<b>FINISH</b>	Chrome

## TECHNICAL LINE DRAWING AND SIZES

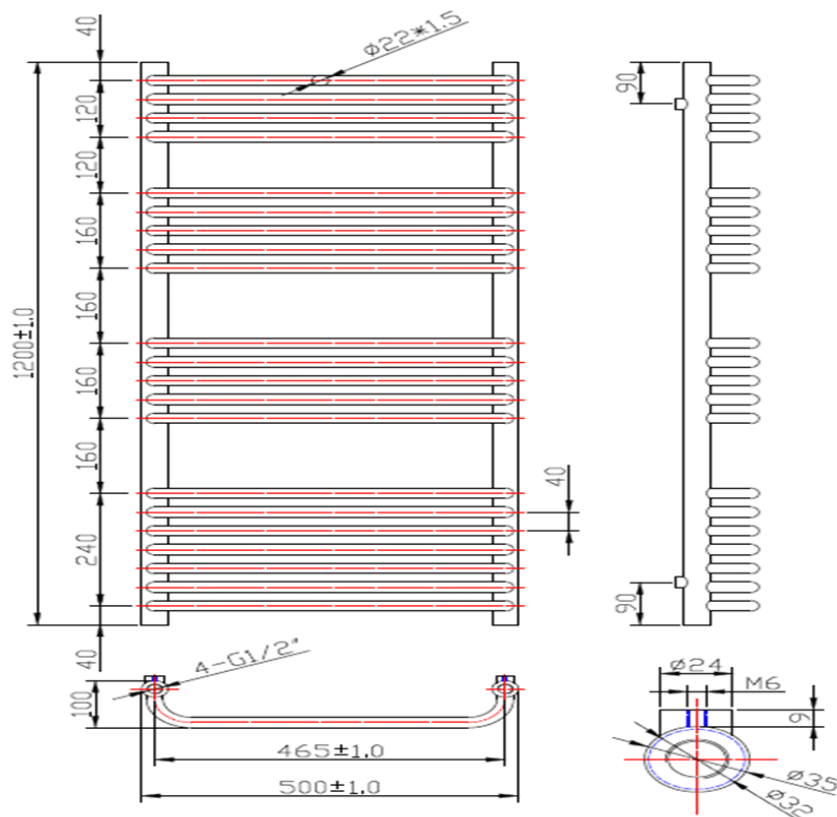

## ADDITIONAL INFORMATION

Size (H * W)	Overall Depth	Overall Depth when mounted	Tapping/ Pipe Inlet Centres	Weight	BTU Output Delta r50	Watts Output Delta r50	BTU Output Delta r60	Watts Output Delta r60	Litre Capacity
1200*500	110	175	465	11.65					5.65
1200*500	110	175	465	11.65	1309	384	1654	485	5.65













## GUARANTEE AND AFTERCARE

During installation extra care must be taken to avoid damaging the fittings. We provide a guarantee against faulty manufacture or materials (excluding serviceable parts), providing they have been installed, cared for and used in accordance with our instructions and good plumbing practice.







Contact Us: Email: [sales@phoenixwhirlpools.co.uk](mailto:sales@phoenixwhirlpools.co.uk)  
Tel: +44 (0)113 201 2260  
Fax: +44 (0)113 201 2268

# Assembly Instructions for Ladder Rail

## Contents List

Ref		Description	Quantity
A		Ladder Rail	1
B		Blanking Plug	1
C		Air Vent Plug	1
D		Wall Support	4
E		Masonry Wall Plug	4
F		Long Screw	4
G		Small Screw	4
H		Spacer	4
I		End Cap	4
J		Cross Bolt	4
K		Bracket Bush	8
L		Rubber Ring	4

## Tools Required(not supplied)

	Description
	PTFE Tape
	Large Flat Screwdriver
	8mm Masonry Bit or 3mm Wood Bit
	Socket Set
	Spanner
	Clean Cloth

## Prior to Installation

- Check that all of the parts are enclosed as per the contents list.
- If there are any missing or damaged parts please contact your supplier immediately.
- The four plastic caps on each corner of the ladder rail should be removed and disposed of.

## Assembly

- 1 Select your desired installation position and ensure that the wall is sufficiently strong enough to hold the weight of the ladder rail. Brick or breezeblock walls are ideal. If positioning on plaster-board wall it **MUST** be fixed to timber batons.

- 2 Screw the blanking plug **B** and air vent plug **C** into the top two threads in the upright channels of the ladder rail **A**. They can fitted on either side. Using a cloth to prevent scratching, tighten with a spanner. Apply PTFE tape.

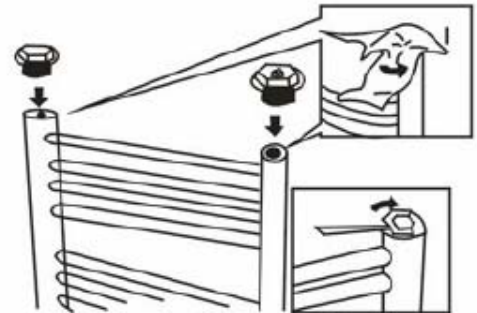

- 3 Thread the tails from the valves (not supplied) into the bottom two threads. Apply PTFE tape.

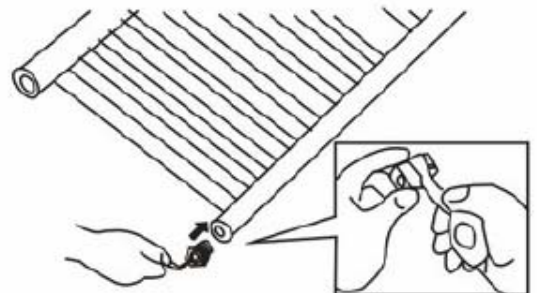

- 4 The wall supports should be fitted at approximately 10cms from the inside edge of the ladder rail - 2 near the top of the ladder rail and 2 near the bottom. The mounting height can be varied between any of the ladder rail bars to allow for finding the best fixing point on the wall. Mark the fixing points with a pencil.

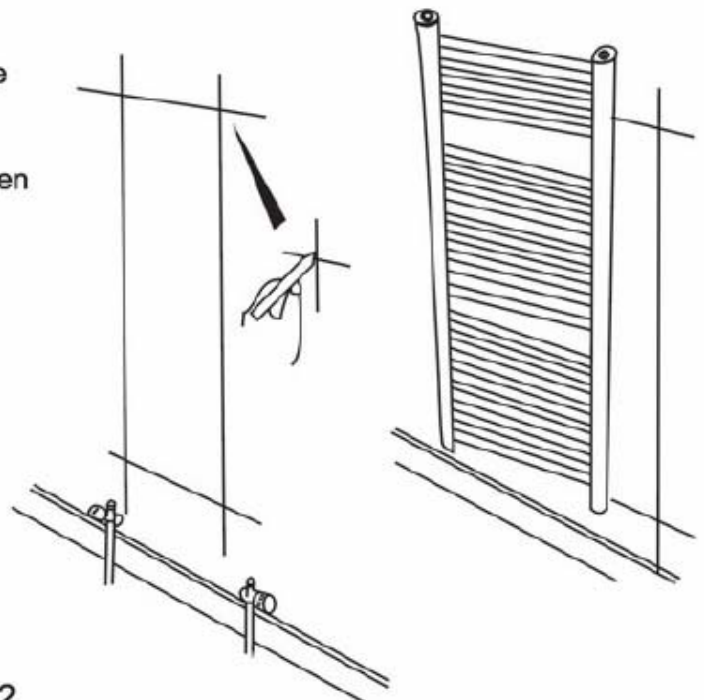

- 5 **Mounting to Brick or Breezeblock**  
 At the required fixing positions drill hole using 8mm masonry bit and insert the wall plug **E** into the hole ensuring it's flush with the wall. Place long screw **F** through the centre of the wall support **D** and tighten into the wall plug.

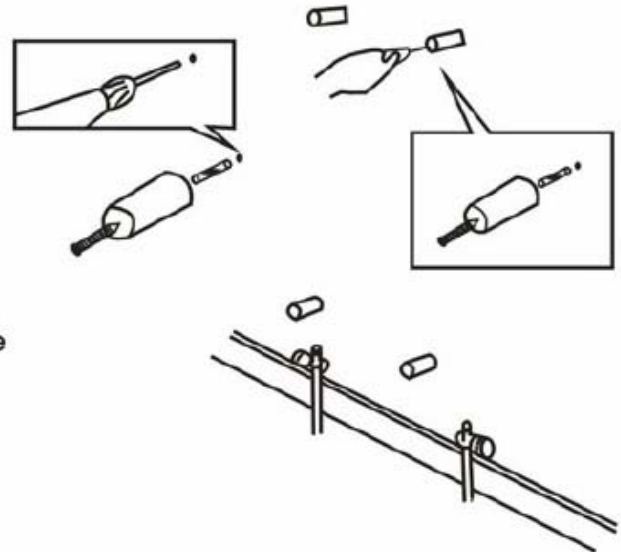

**Mounting to Wood**

Place long screw **F** through the centre of the wall support **D** and screw into the wooden baton at the required fixing positions.

- 6 Place the spacer **H** inside the wall support and insert the small screw **G** into the hole in the wall support. Don't over-tighten to allow for adjustment later.

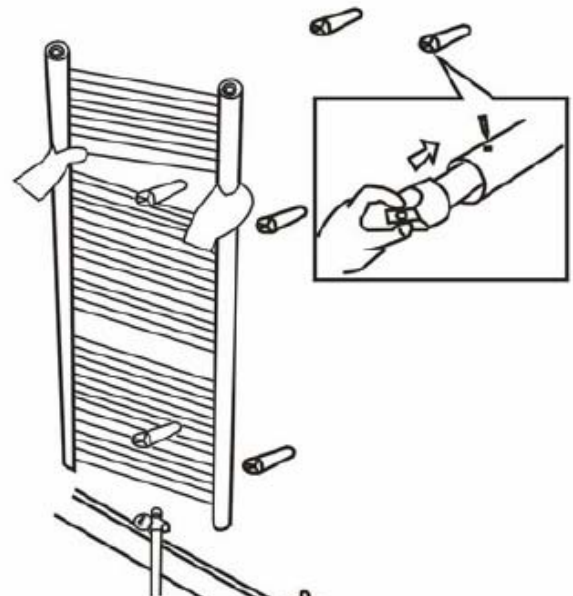

- 7 Offer the ladder rail **A** up to the fixing brackets and place bolt **J** through the bracket bush **K**.



Place the bolt between the selected ladder rail bars and thread into the wall support ensuring the square face of the bracket bush is aligned with the ladder rail.

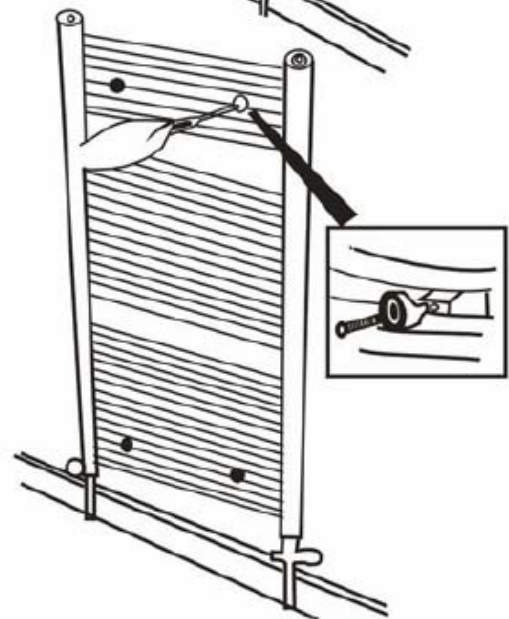

## INSTALLATION GUIDE

- 8 Push the rail flat against the wall, adjust to required depth and tighten the small screws to secure. Push the end caps I over each of the bracket heads until they click into position.

- 9 Connect the valve tail to the ladder rail and tighten securely. Apply PTFE tape.

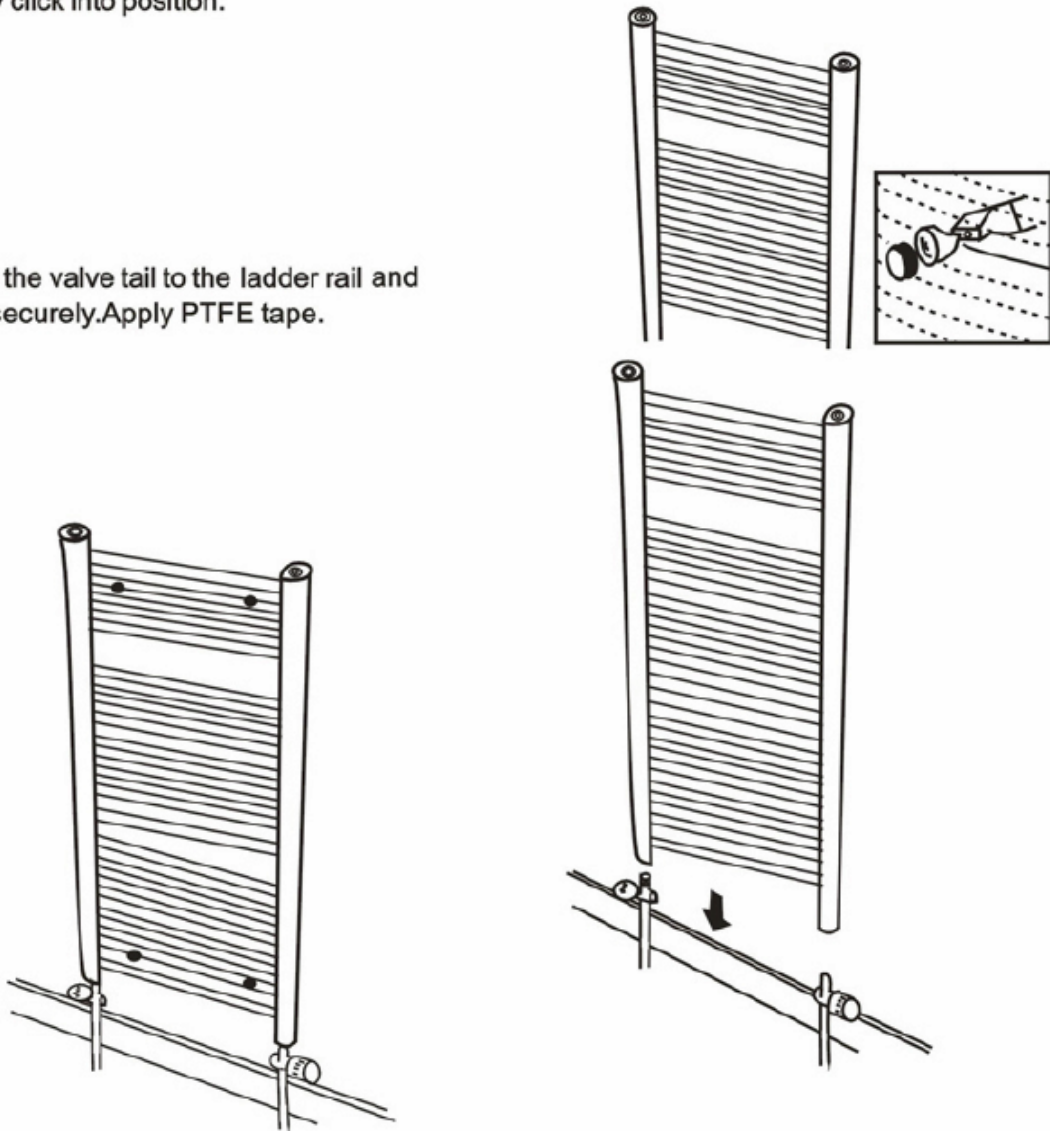

### **Important**

- Wipe the surface clean with a soft, damp cloth. Never use abrasive cleaners on this product as they will damage the surface.