

RANGE	INSTALLATION TYPE	PRODUCT DESCRIPTION
Module	Wall	Module 2 Control Diverter Trimset Matt Black

CODE	FINISH	APPLICATION	MIN PRESSURE
PROMODDIVLBPM	Matt Black	Powder Coated	NA

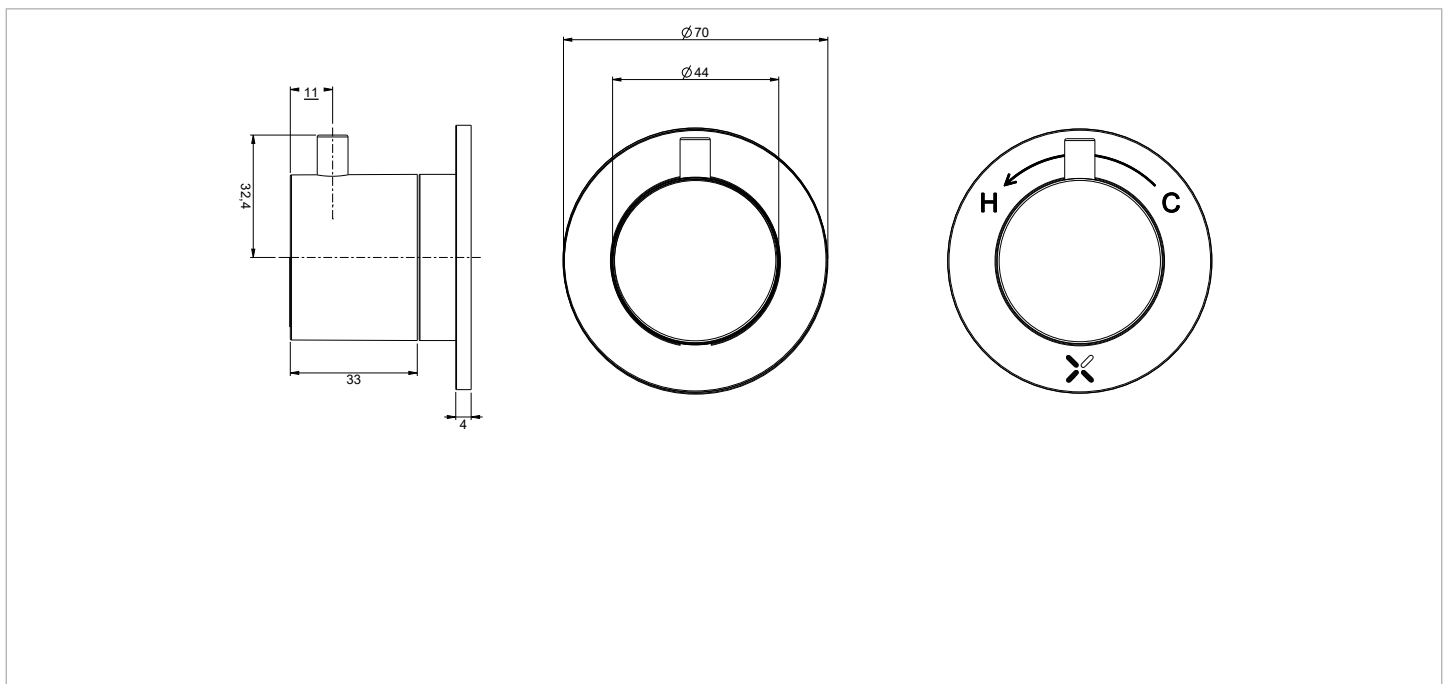

HEADWORK	NA
CONNECTIONS	NA
APPROVALS	N/A
WARRANTY*	15 Years



RANGE	INSTALLATION TYPE	PRODUCT DESCRIPTION
Module	Wall	Module 2 Outlet Valve

CODE	FINISH	APPLICATION	MIN PRESSURE
MOD1500R	N/A	N/A	1.0 bar



HEADWORK	Thermo cartridge + flow control/s
CONNECTIONS	G3/4"
APPROVALS	N/A
WARRANTY*	15 Years

